



P.O.Box: 124844 - Dubai - UAE  
Tel: +971 4 885 1976  
Fax: +971 4 885 1977



## FIBERGLASS SPIRAL CHUTE



MANUFACTURER: Al Mustaqbal Fiberglass Ind. LLC P.O.Box: 31804 - Sharjah - UAE



# FIBERGLASS SPIRAL CHUTE

## Introduction:

- In certain applications, a spiral chute is all that is needed to gently move products down to a lower level while maintaining orientation.
- The angles and degree of the profile design and infeed / outfeed sections, ensure a smooth transition of product, whilst controlling descent speed.
- The wear resistant characteristic (special gel coat) on our fiberglass chute assists products to flow freely, gently and safely with minimum wear.

## Fields of Applications:

- Airports baggage handling.
- Distribution and warehouses.
- Postal and Parcel handling.
- Food processing plants.
- Newspaper industry.
- Pharmaceutical industry.

## Advantages of Fiberglass Chutes:

- Light weight ( 1/3 of steel )
- Corrosion resistant to harsh environment
- Fire retardant
- Durable
- Virtually maintenance free
- Scratch resistant
- Easily repairable
- High strength
- Variety of colors
- Extremely quick installation
- Fully assembled at time of shipment

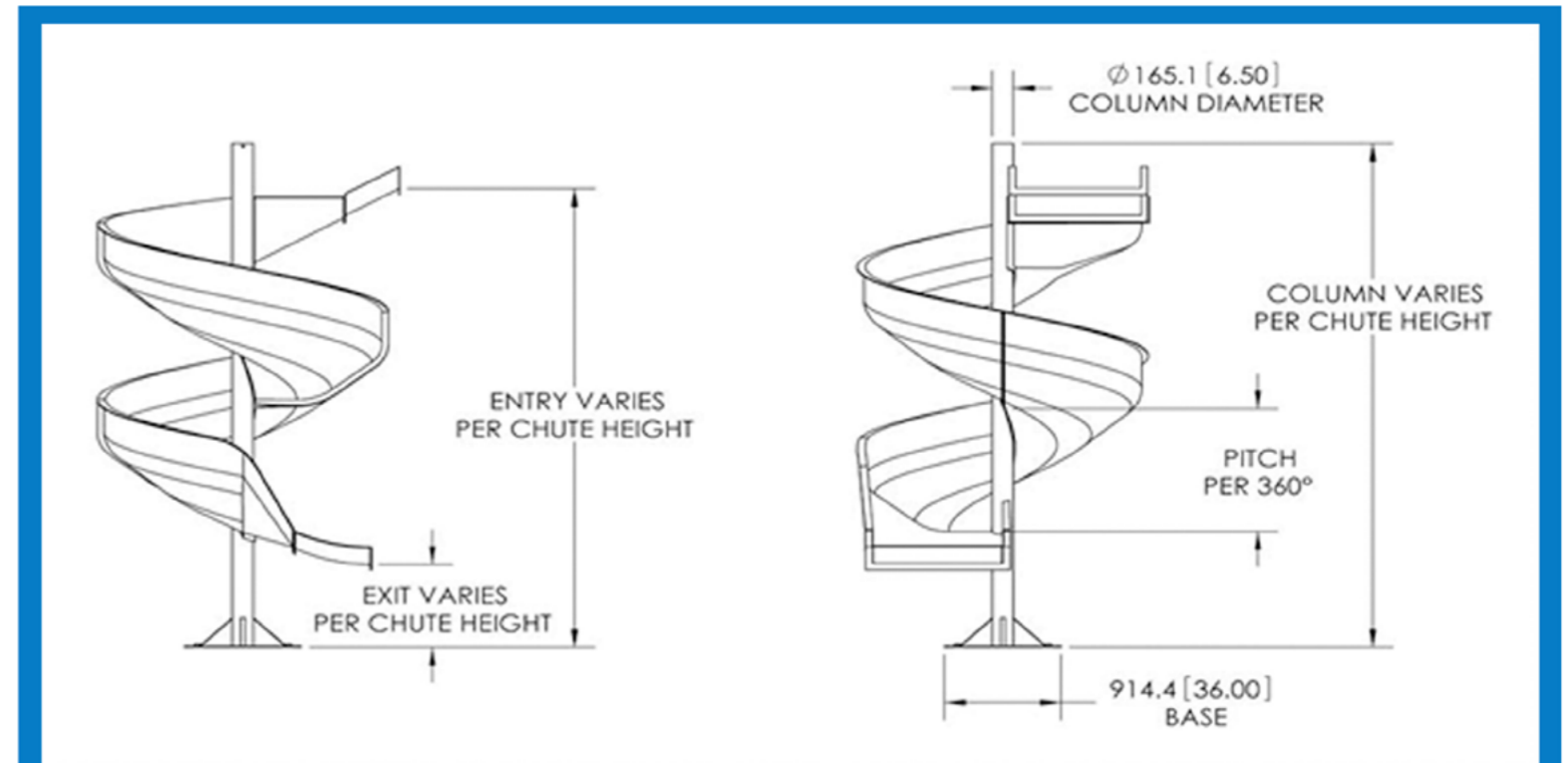

Each profile is available in clockwise and anti-clockwise orientation providing more flexibility when arranging material flow. The standard profile configurations as per below. Non standard configuration can also be designed.

## Clockwise:

I: 90°

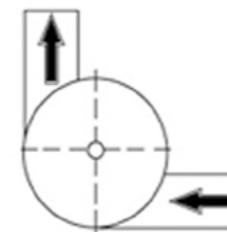

II: 180°

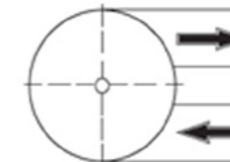

III: 270°

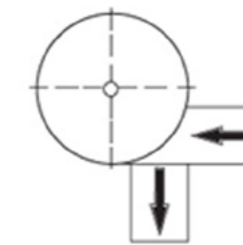

IV: 360°



## Anti-Clockwise:

I: 90°

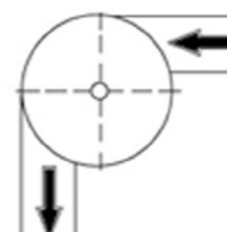

II: 180°

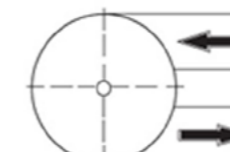

III: 270°

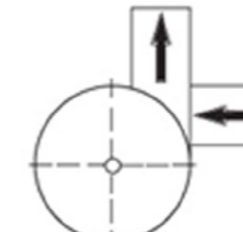

IV: 360°

